

AN1101SSM

CMOS single power supply

■ Overview

AN1101SSM is an operational amplifier with a single power supply by CMOS diffusion process.

It has low current-consumption compared to general purpose operational amplifier by bipolar diffusion process. 0 V to V_{DD} is available for both input voltage and output voltage. And this IC is widely applicable to the battery-driven equipment and to many amplifier circuits which adopt small package products.

■ Features

- Low current-consumption: $I_{DD} = 55 \mu\text{A}$ (typ.), $V_{DD} = 3 \text{ V}$
- Operating input/output voltage range: 0 V to V_{DD}
- Small offset voltage: 0.5 mV (typ.)
- Small input bias current: 1 pA (typ.)
- Operating supply voltage range:
2.5 V to 5.5 V or $\pm 1.25 \text{ V}$ to $\pm 2.75 \text{ V}$

■ Applications

- Various small-size general consumer electronics equipment

■ Block Diagram

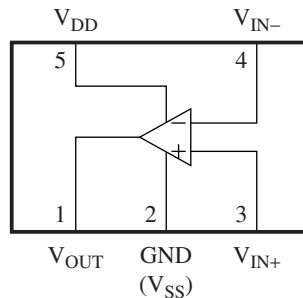

■ Pin Descriptions

| Pin No. | Symbol | Description |
|---------|------------------|--|
| 1 | V_{OUT} | Output |
| 2 | GND (V_{SS}) | Ground, V_{SS} (negative supply) at using two power supply |
| 3 | V_{IN+} | Input (positive) |
| 4 | V_{IN-} | Input (negative) |
| 5 | V_{DD} | Power supply |

Note) The AN1101SSM has been designed for general consumer electronics equipment, not for the specific one requiring such a high reliability that may prevent it from threatening the human lives.

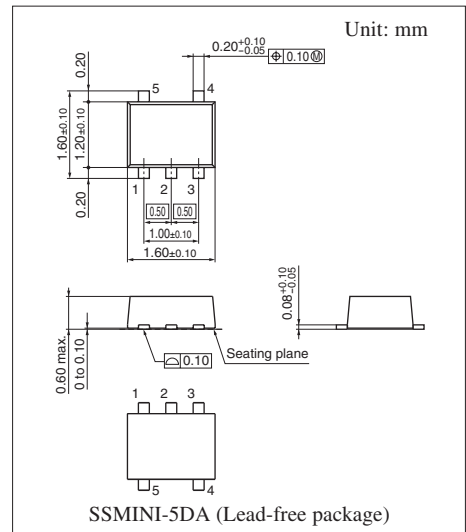

■ Absolute Maximum Ratings

| Parameter | Symbol | Rating | Unit |
|----------------------------------|-----------|----------------------|------|
| Supply voltage | V_{DD} | 5.6 | V |
| Differential input voltage | DV_{IN} | ± 5.6 | V |
| Input voltage | V_{IN} | V_{SS} to V_{DD} | V |
| Supply current | I_{DD} | — | mA |
| Power dissipation *2 | P_D | 50 | mW |
| Operating ambient temperature *1 | T_{opr} | -30 to +85 | °C |
| Storage temperature *1 | T_{stg} | -55 to +125 | °C |

Note) 1. *1: Except for the operating ambient temperature and storage temperature, all ratings are for $T_a = 25^\circ\text{C}$.

*2: The value at $T_a = +85^\circ\text{C}$.

2. This IC is not suitable for car electrical equipment.

■ Recommended Operating Range

| Parameter | Symbol | Range | Unit |
|----------------|----------|--------------------------|------|
| Supply voltage | V_{DD} | 2.5 to 5.5 | V |
| | | ± 1.25 to ± 2.75 | |

■ Electrical Characteristics at $V_{DD} = 3.0\text{ V}$, $V_{SS} = \text{GND}$, $T_a = 25^\circ\text{C} \pm 2^\circ\text{C}$

| Parameter | Symbol | Conditions | Min | Typ | Max | Unit |
|---|------------|---|------|------|------|---------------|
| Input offset voltage | V_{IO} | Buffer circuit | — | 0.5 | 5.5 | mV |
| Common-mode input voltage | CMV_{IN} | $R_S = 10\text{ k}\Omega$, $R_F = 10\text{ k}\Omega$ | 0 | — | 3 | V |
| Open-loop gain | GV | $f = 100\text{ Hz}$ | 60 | 90 | — | dB |
| Maximum output amplitude voltage 1 | V_{OH} | $R_L \geq 10\text{ k}\Omega$ | 2.90 | 2.98 | — | V |
| Maximum output amplitude voltage 2 | V_{OL} | $R_L \geq 10\text{ k}\Omega$ | — | 0.01 | 0.05 | V |
| Common-mode input voltage rejection ratio | CMRR | $V_{IN} = 0.0\text{ V}$ to 3.0 V , $R_S = R_F = 10\text{ k}\Omega$ | 50 | 65 | — | dB |
| Supply voltage ripple rejection ratio * | SVRR | $V_{DD} = 2.5\text{ V}$ to 5.5 V | 55 | 70 | — | dB |
| Supply current | I_{DD} | No load | — | 55 | 100 | μA |

Note) * : Except for the supply voltage ripple rejection ratio (SVRR), $V_{DD} = 3\text{ V}$.

• Design reference data

Note) The characteristics listed below are theoretical values based on the IC design and are not guaranteed.

| Parameter | Symbol | Conditions | Reference | Unit |
|----------------------|----------|------------------------------|-----------|------------------|
| Offset current | I_O | — | 1 | pA |
| Input bias current | I_{IO} | — | 1 | pA |
| Slew rate | SR | $R_L \geq 10\text{ k}\Omega$ | 0.35 | V/ μs |
| Zero-cross frequency | f_T | $A_V = 1$ | 0.8 | MHz |

■ Technical Data

- $P_D - T_a$ curve of SSMINI-5DA

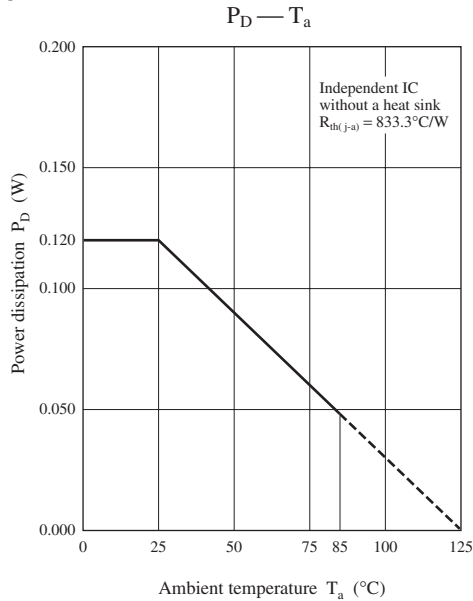

- Main characteristics

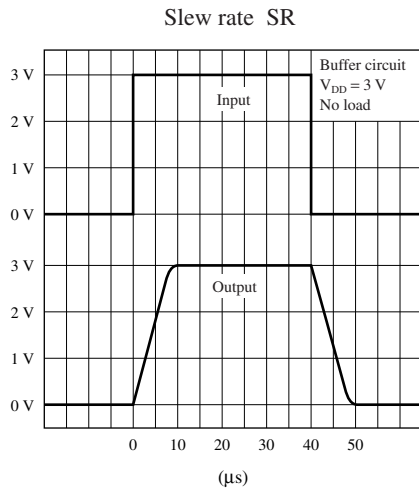
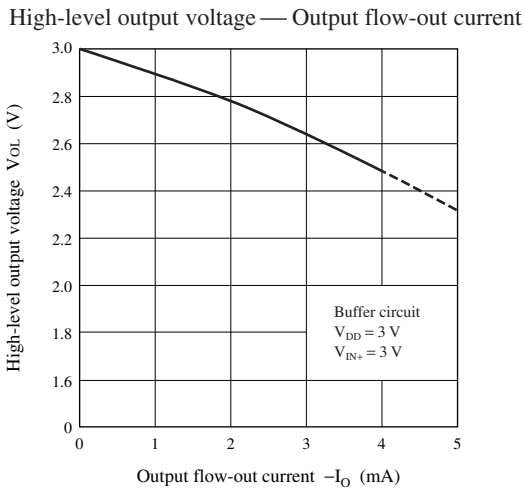
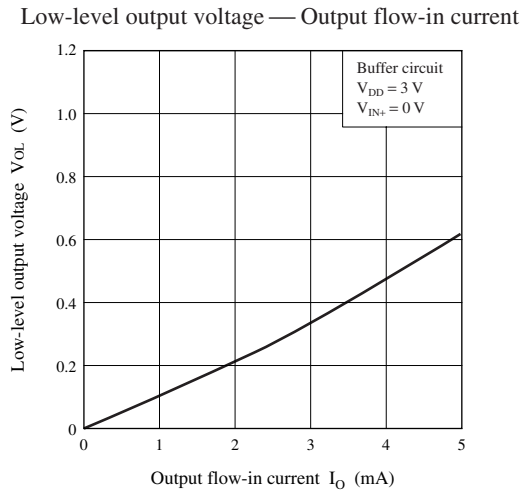
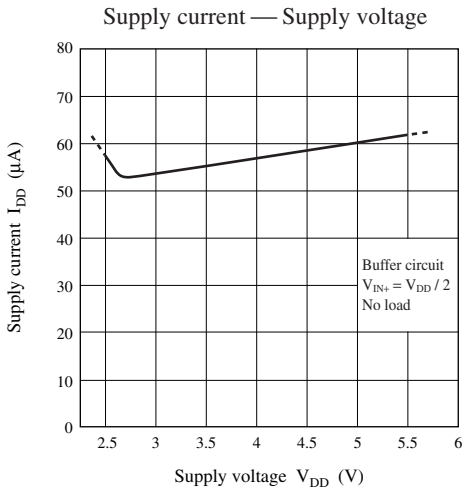

■ Technical Data (continued)

• Main characteristics (continued)

Offset voltage — Ambient temperature

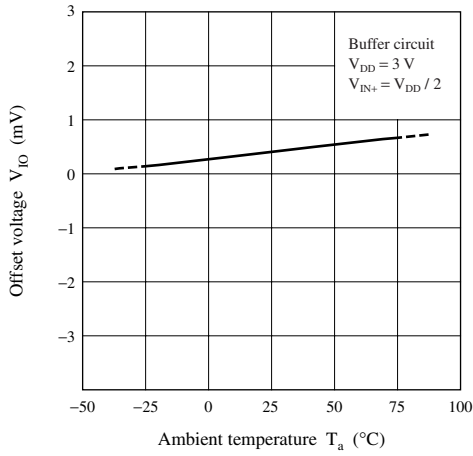

Supply current — Ambient temperature

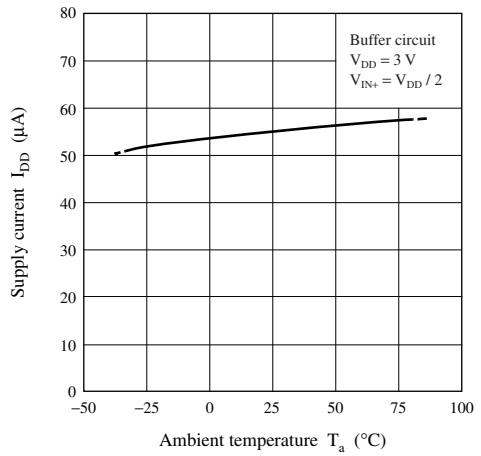

Voltage gain · Phase — Frequency characteristics

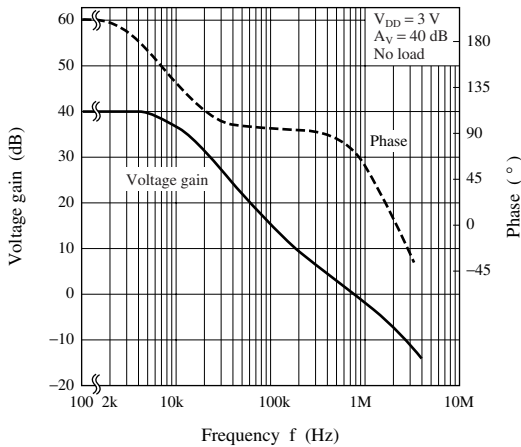

■ Application Circuit Example

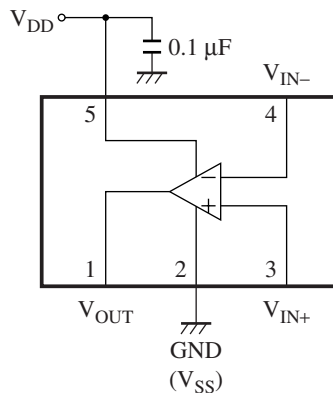

Request for your special attention and precautions in using the technical information and semiconductors described in this material

- (1) An export permit needs to be obtained from the competent authorities of the Japanese Government if any of the products or technologies described in this material and controlled under the "Foreign Exchange and Foreign Trade Law" is to be exported or taken out of Japan.
- (2) The technical information described in this material is limited to showing representative characteristics and applied circuits examples of the products. It neither warrants non-infringement of intellectual property right or any other rights owned by our company or a third party, nor grants any license.
- (3) We are not liable for the infringement of rights owned by a third party arising out of the use of the product or technologies as described in this material.
- (4) The products described in this material are intended to be used for standard applications or general electronic equipment (such as office equipment, communications equipment, measuring instruments and household appliances).
Consult our sales staff in advance for information on the following applications:
 - Special applications (such as for airplanes, aerospace, automobiles, traffic control equipment, combustion equipment, life support systems and safety devices) in which exceptional quality and reliability are required, or if the failure or malfunction of the products may directly jeopardize life or harm the human body.
 - Any applications other than the standard applications intended.
- (5) The products and product specifications described in this material are subject to change without notice for modification and/or improvement. At the final stage of your design, purchasing, or use of the products, therefore, ask for the most up-to-date Product Standards in advance to make sure that the latest specifications satisfy your requirements.
- (6) When designing your equipment, comply with the guaranteed values, in particular those of maximum rating, the range of operating power supply voltage, and heat radiation characteristics. Otherwise, we will not be liable for any defect which may arise later in your equipment.
Even when the products are used within the guaranteed values, take into the consideration of incidence of break down and failure mode, possible to occur to semiconductor products. Measures on the systems such as redundant design, arresting the spread of fire or preventing glitch are recommended in order to prevent physical injury, fire, social damages, for example, by using the products.
- (7) When using products for which damp-proof packing is required, observe the conditions (including shelf life and amount of time let standing of unsealed items) agreed upon when specification sheets are individually exchanged.
- (8) This material may be not reprinted or reproduced whether wholly or partially, without the prior written permission of Matsushita Electric Industrial Co., Ltd.